



Check Components

ASSEMBLY INSTRUCTIONS

SM963605PWB



Oil all sockets
before assembly

Components:

Panels:

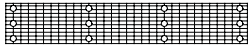

(3) Floor Panels
(open hole sockets)

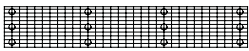

(2) 1st Level
(open hole sockets)

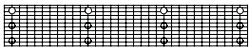

(2) 2nd Levels
(4 open hole sockets)



(1) 3rd Level
(closed hole sockets)

Waterbeds:

(8) - open hole sockets
(2) - closed hole sockets

Legs:

(24) - 12"
(16) - 24"
(4) - 36"

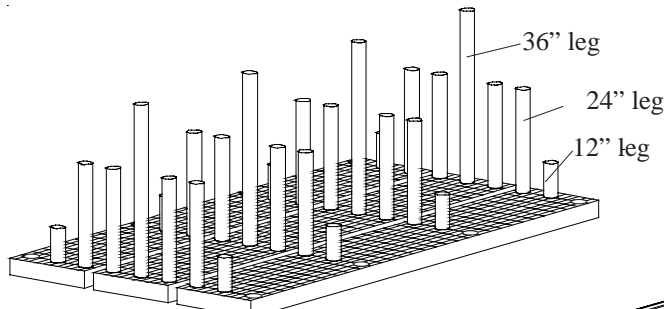
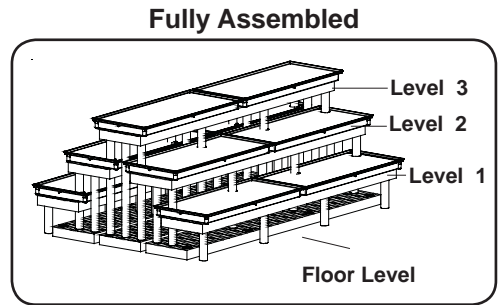

Step 1

Floor Level

Place legs as shown.
Push legs through to ground.

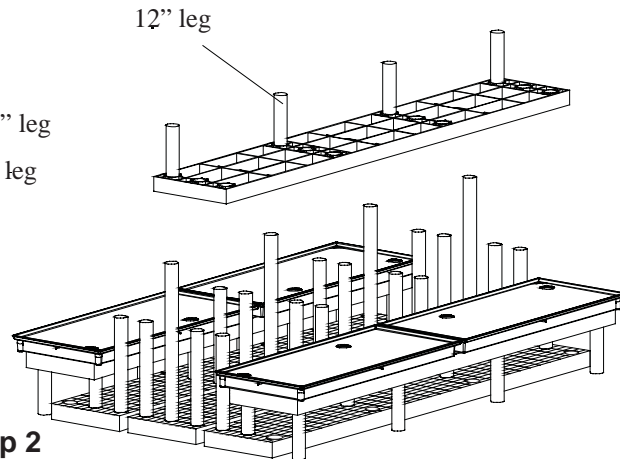

Step 2

Level 1

- A. Invert (2) Level 1 panels and insert (4) 12" Legs in outside sockets.
- B. Next, return Level 1 panels to the upright position and place on 12" legs overhanging outside edge as shown. Place Waterbeds on Level 1 panels with open hole sockets facing in and aligned with sockets of panel.

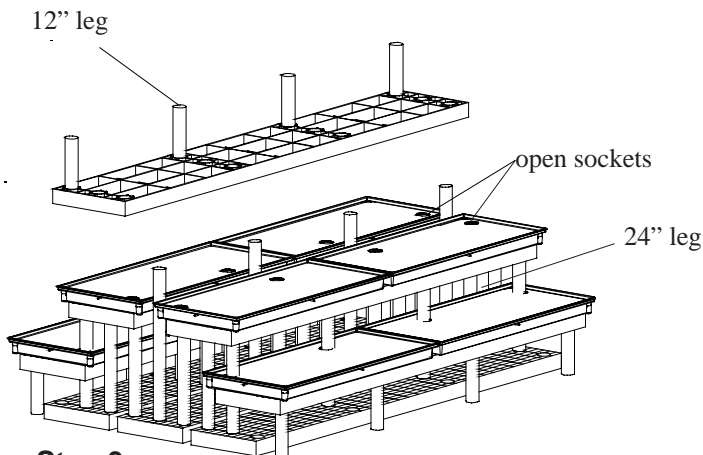

Step 3

Level 2

- A. Invert (2) Level 2 panel and place (4) 12" legs in outside sockets.
- B. Next, return Level 2 panels to the upright position and place on 24" legs overhanging outside edge while inserting 12" Legs into open sockets of Waterbeds on Level 1 panel. Place Waterbeds on Level 2 panel with open hole sockets facing in and aligned with sockets of panel.

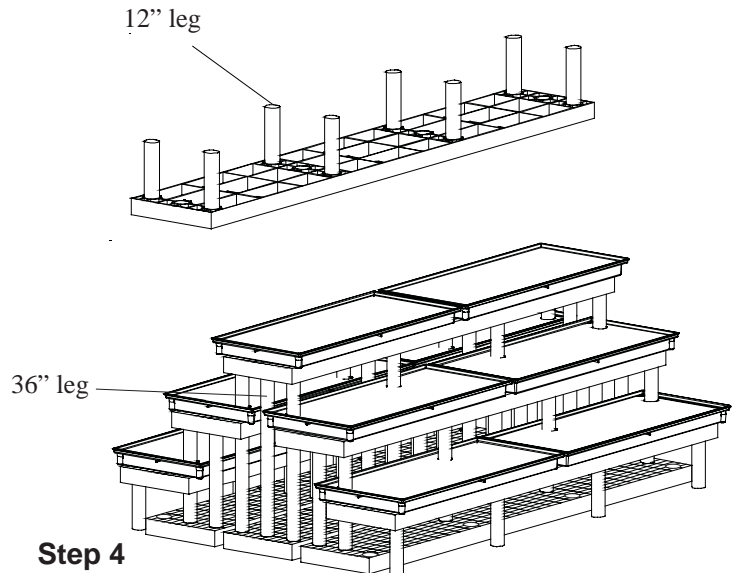

Step 4

Level 3

- A. Invert Level 3 panel and place (8) 12" legs in outside sockets.
- B. Return Level 3 panel to the upright position. Next, position center sockets of Level 3 panel on 36" legs while panel over hangs level 2. Insert 12" Legs into open sockets of Waterbeds on Level 2 panel. Then place Waterbeds on Level 3 Panel as shown.