

SM367203W

Components:

Panels:



(2) Floor Panels
(open hole sockets)

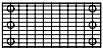

(1) 1st Level
(closed hole sockets)

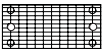

(2) 2nd and 3rd Levels
(open center
hole sockets)

Legs:

(8) - 12"
(2) - 24"
(2) - 36"
(4) - 72"

**Oil All Sockets
Before Assembly**

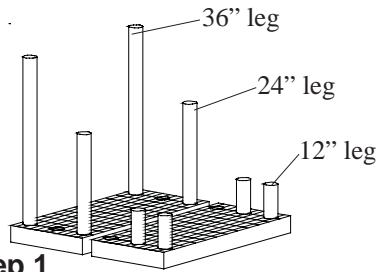

Step 1 Floor Level

Place legs as shown.
Push legs through to ground.

Fully Assembled

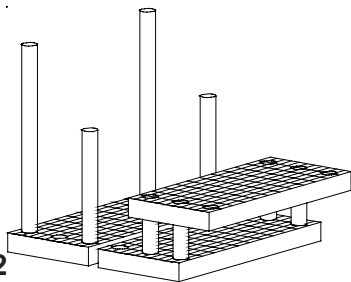
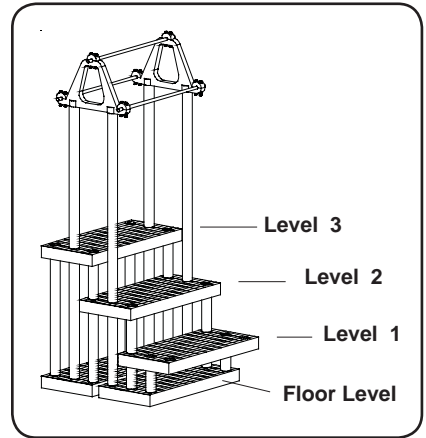

Step 2 Level 1

Position the Level 1 Panel on 12" legs
overhanging outside edge as shown.

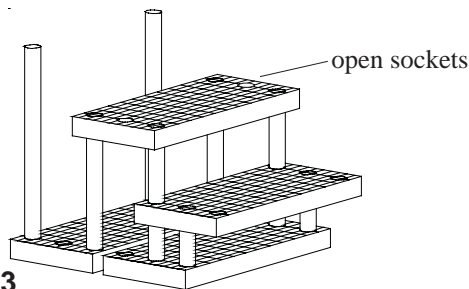

Step 3 Level 2

- Invert Level 2 panel and place
(2) 12" legs in outside sockets.
- Position panel on 24" legs
while placing 12" legs on the Level 1 panel.
Push panel down so that the 24" legs are
seated in the sockets.

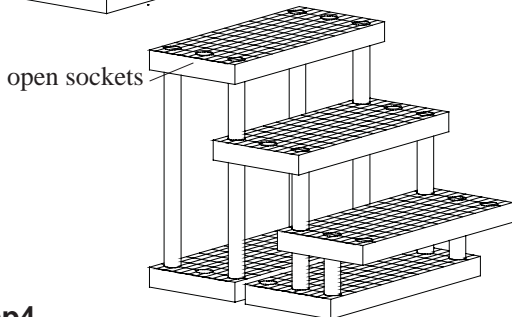
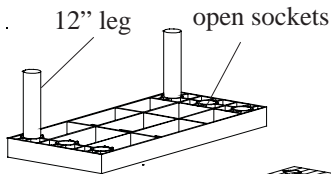
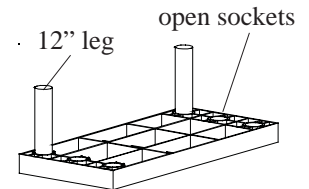

72" leg

**Oiling the sockets will
make this step easier.**

Step 4 Level 3

- Invert Level 3 panel and place
(2) 12" legs in outside corners.
- Position panel on 36" legs while placing 12"
legs on the Level 2 panel. Push panel down so
that the 36" legs are seated in the sockets.

Step 5 Plant Hanger

Insert 72" legs into center open hole
sockets of Levels 3 and 2. Slide legs all
the way through open hole sockets in floor
panels. (Make sure to push legs all the
way down to the floor).

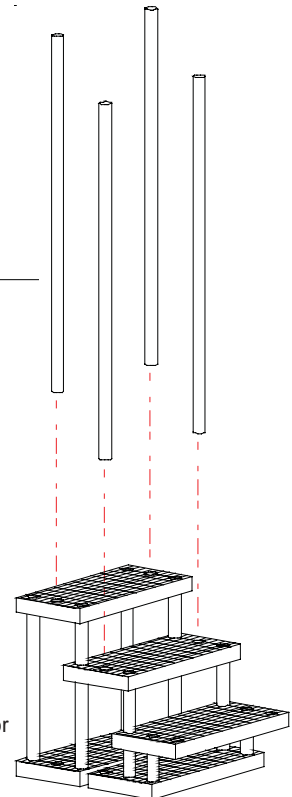

ASSEMBLY INSTRUCTIONS

SM367203W

Oil All Sockets
Before Assembly

- | |
|-------------------------|
| Components: |
| Plant Hanger Tops: 2 |
| Plant Hanger Collars: 6 |
| Plant Hanger Poles: 3 |
| Bolts: 12 |
| Wingnuts: 12 |

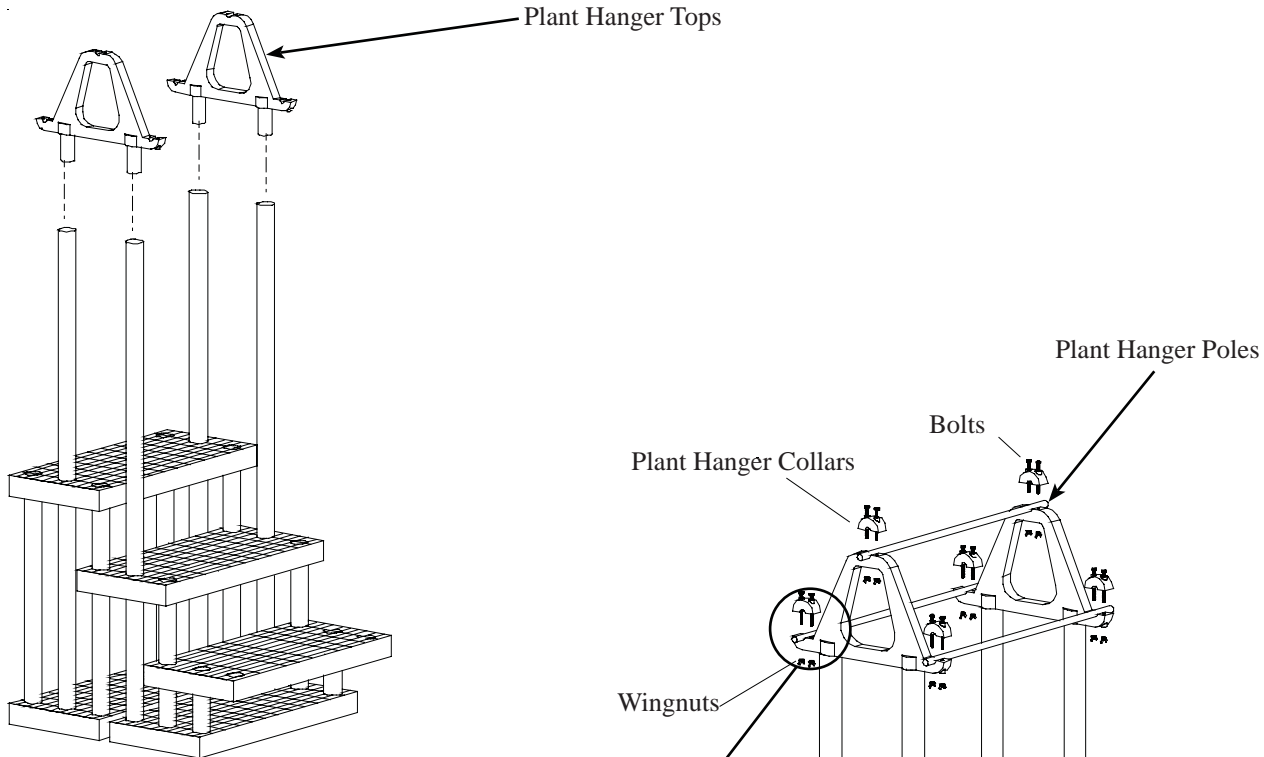

Step 6 Plant Hanger

Insert Plant hanger tops in 72" legs as shown.

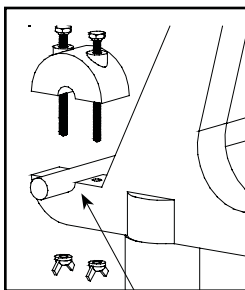

Groove for
Plant Hanger
Poles

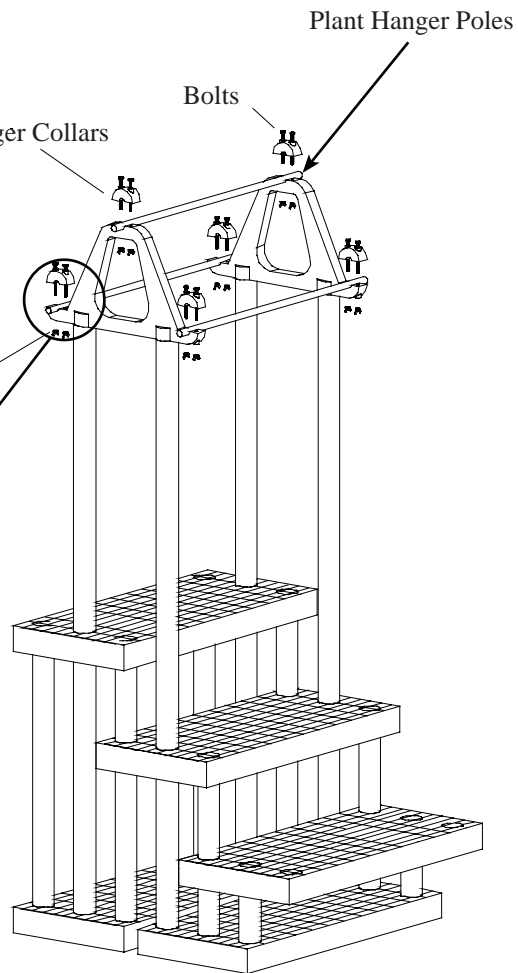

Step 7 Plant Hanger

Next, place 36" plant hanger poles into small groove in plant hanger top. Place plant hanger collars over poles and fasten down with bolts and wingnuts.