

ASSEMBLY INSTRUCTIONS

SC667203WWB

Components:

Panels:

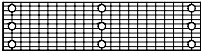

(2) Floor Panels
(open hole sockets)

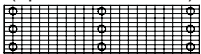

(1) 1st Level
(closed hole sockets)



(2) 2nd and 3rd Levels
(open center hole sockets)

Legs:

(12) - 12"
(3) - 24"
(3) - 36"
(6) - 72"

Waterbeds:

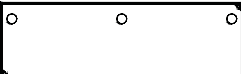

Level 1: open holes

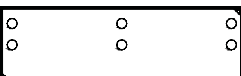

Level 2: open holes

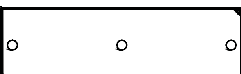

Level 3: open holes

Caster Bars (3)

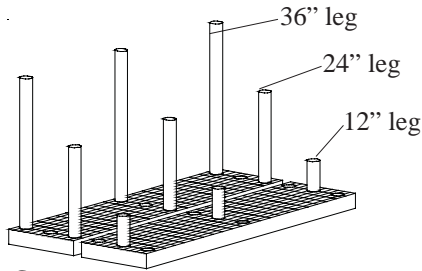

Step 1

Floor Level

Place legs as shown.
Push legs through to ground.

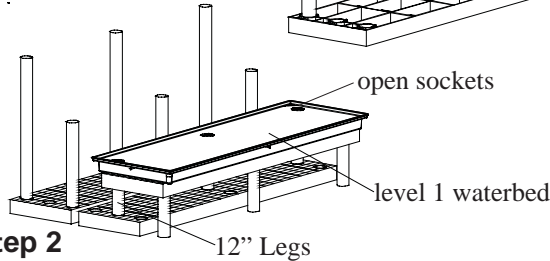
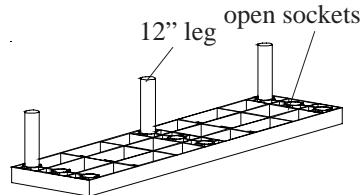

Step 2

Level 1

Position the Level 1 Panel on 12" legs overhanging outside edge. Next, position Level 1 waterbed (open holes) on level 1 panel with holes facing to the back as shown.

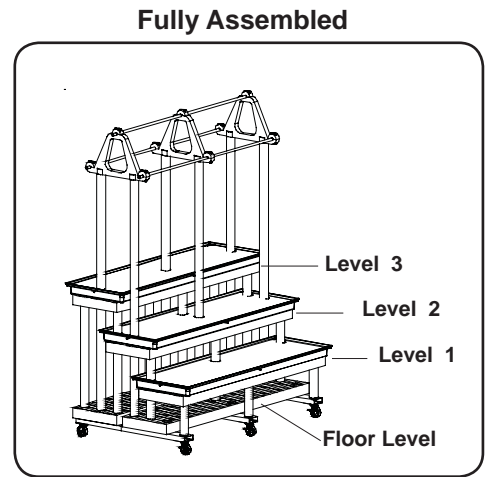

Fully Assembled

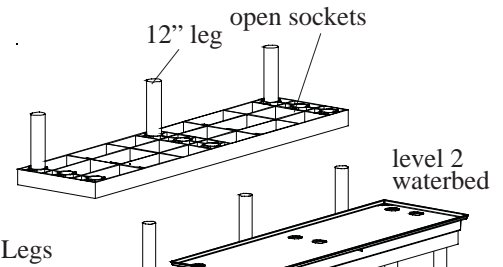

Step 3

Level 2

A. Invert Level 2 panel and place (3) 12" legs in outside sockets.

B. Position panel on 24" legs placing 12" legs into the Level 1 waterbed open holes. Push panel down so that the 24" 12" Legs legs are seated in the sockets.

C. Next, position Level 2 waterbed (open holes) on level 2 panel with holes facing to the back as shown.

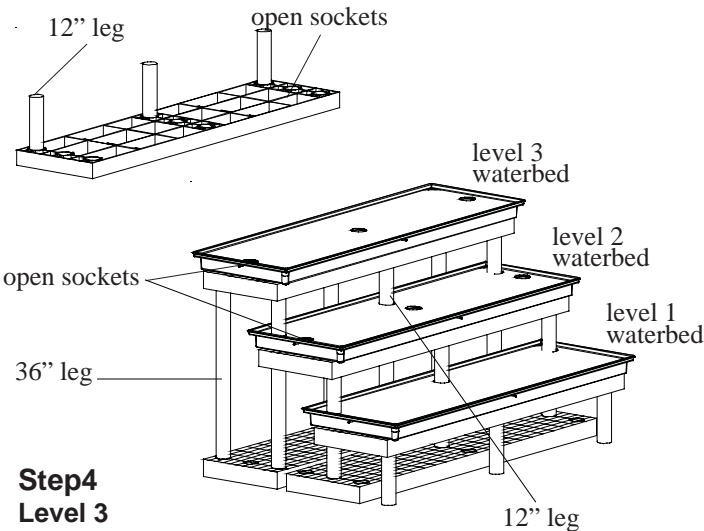

Step 4

Level 3

A. Invert Level 3 panel and place (3) 12" legs in outside corners.

B. Position panel on 36" legs while placing 12" legs into the Level 2 waterbed open holes. Push panel down so that the 36" legs are seated in the sockets.

C. Next, position Level 3 waterbed (open holes) on level 3 panel with center holes in the center as shown.

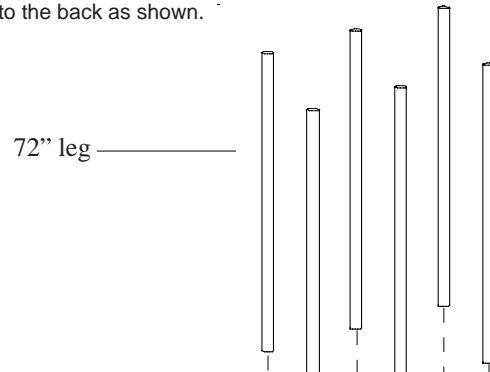

Step 5

Plant Hanger

Insert (3) 72" legs into center open hole of level 3 waterbed open holes and (3) 72" legs into center open hole of level 2 waterbed. Slide legs all the way through open hole sockets in floor panels. (Make sure to push legs all the way down to the floor).

ASSEMBLY INSTRUCTIONS

SC667203WWB

Oil all sockets
before assembly



**Check
Components**

- Components:**
- Plant Hanger Tops: 3
 - Plant Hanger Collars: 9
 - Plant Hanger Poles: 3
 - Bolts: 18
 - Wingnuts: 18

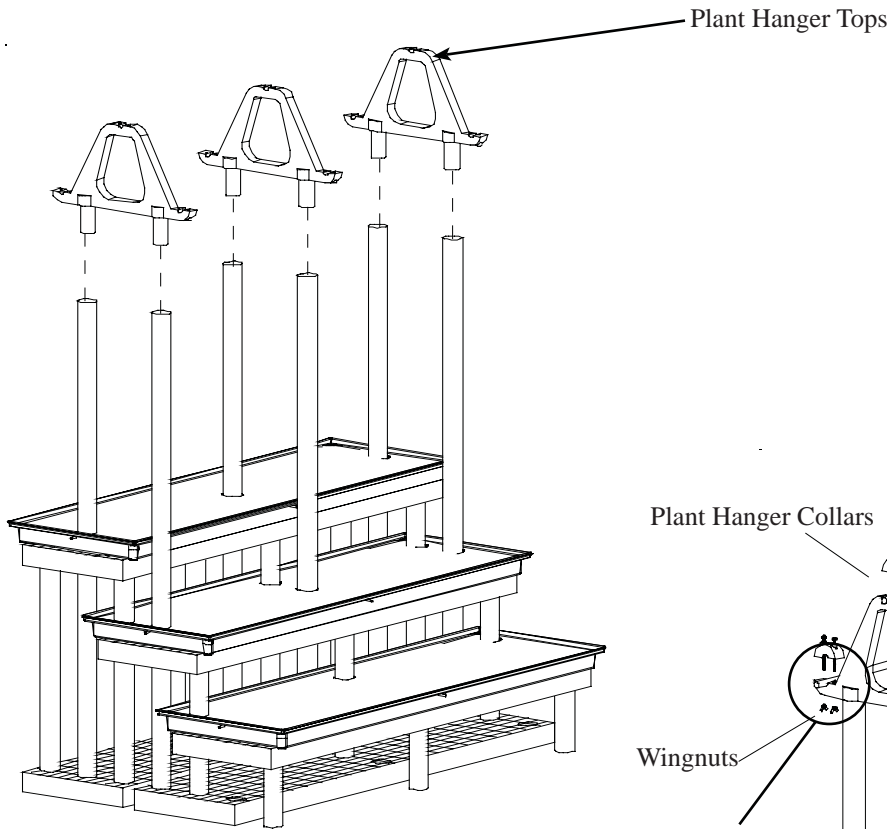

Step 6 Plant Hanger

Insert Plant hanger tops in 72" legs as shown.

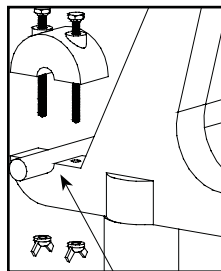

Groove for
Plant Hanger
Poles

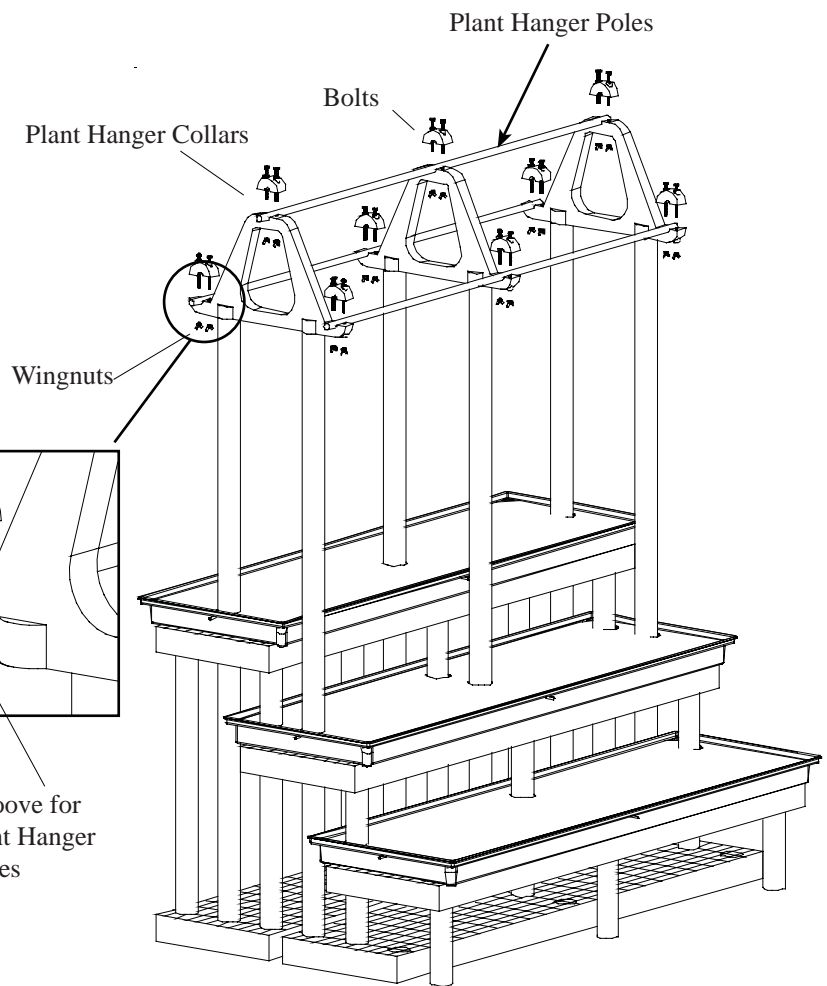

Step 7 Plant Hanger

Next, place 63" plant hanger poles into small groove in plant hanger top. Place plant hanger collars over poles and fasten down with bolts and wingnuts.

ASSEMBLY INSTRUCTIONS

SC667203WWB



Oil all sockets
before assembly

Accessories:
(3) - Mobile Bars

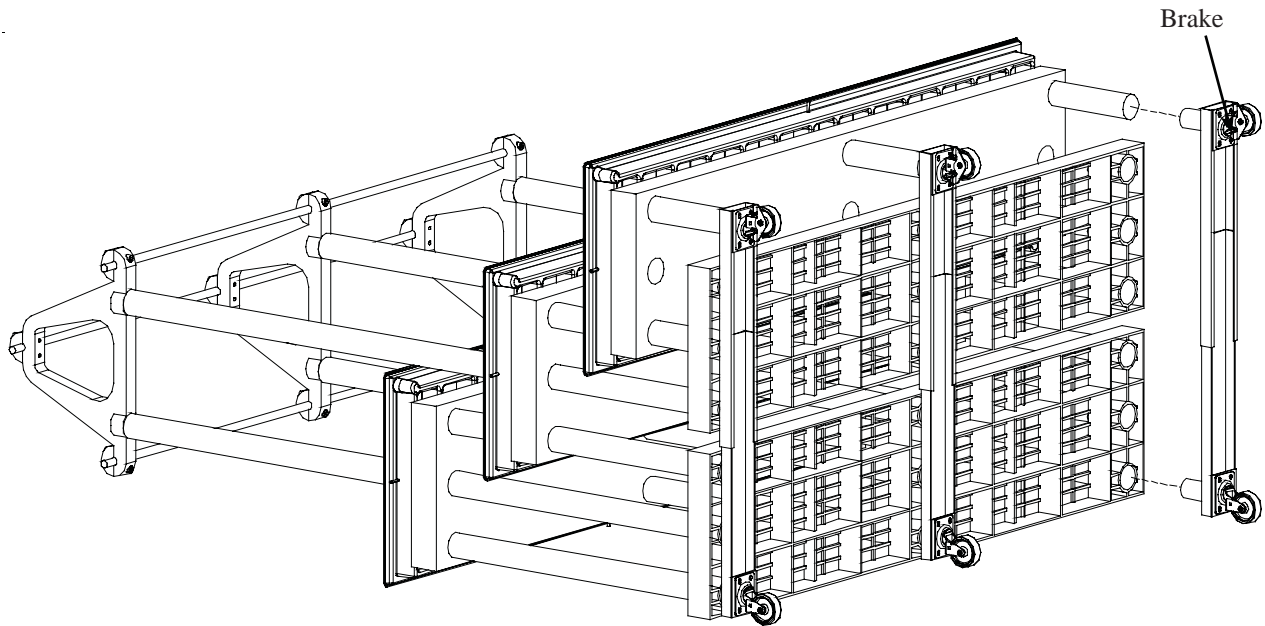

Step 8 Mobile Bar

Position fixture on its back side and insert the stems of the mobile bar inside the sockets as shown.

Brakes go to the front of the fixture.