

# BenchmasterR ASSEMBLY INSTRUCTIONS

## SINGLE LEVEL UNIT

Oil all sockets before assembly

**Components:**  
BM361801S-36"

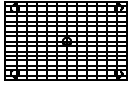

**Panels:** (1) - 24"x36"  
**Legs:** (4) - 18" legs

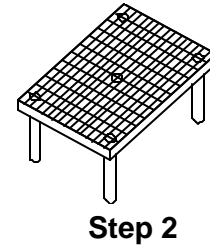
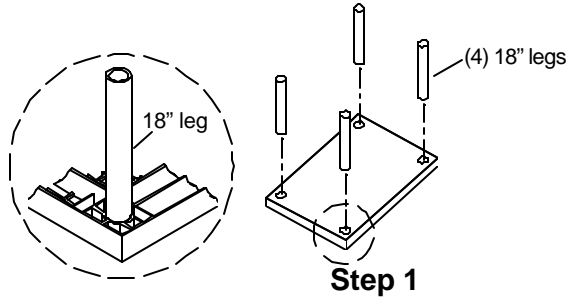

**Components:**  
BM661801S-66"

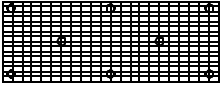

**Panels:** (1) - 24"x66"  
**Legs:** (6) - 18" legs

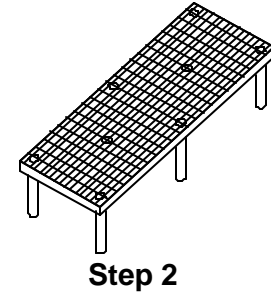
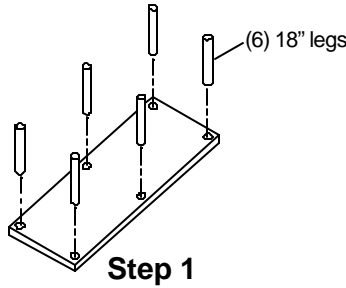

**Components:**  
BM961801S-96"

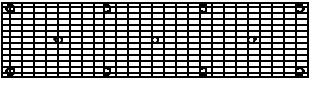

**Panels:** (1) - 24"x96"  
**Legs:** (8) - 18" legs

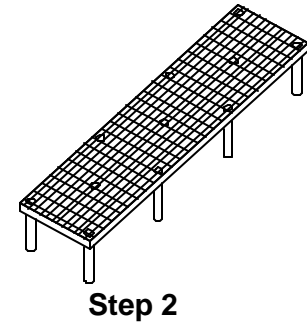
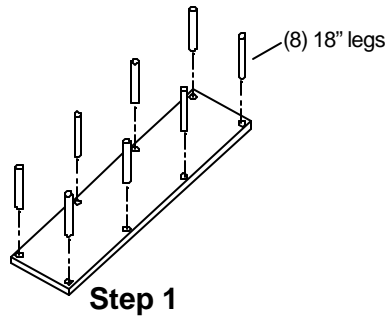

**Components:**  
BM661801S3-66"

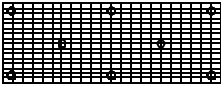

**Panels:** (1) - 36"x66"  
**Legs:** (8) - 18" legs

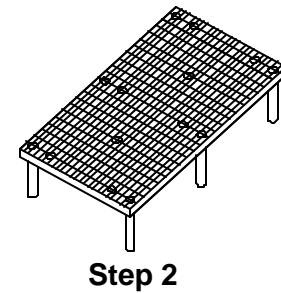
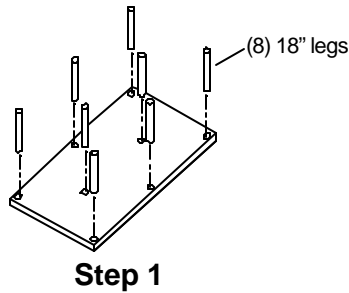

**Components:**  
BM961801S3-96"

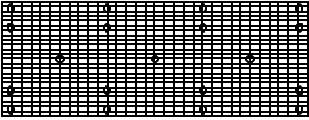

**Panels:** (1) - 36"x96"  
**Legs:** (11) - 18" legs

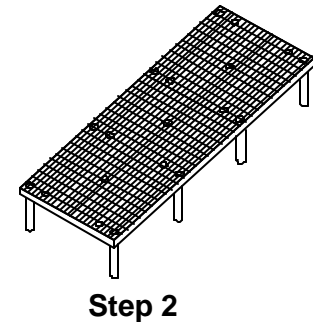
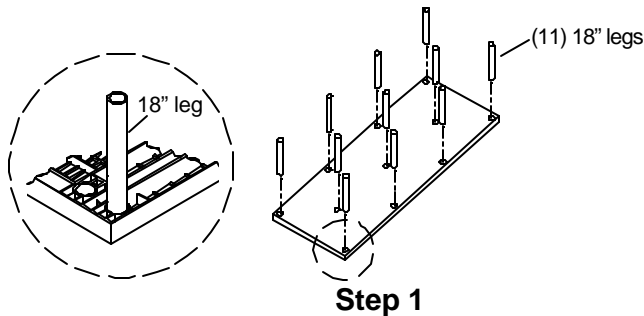

### Step 1

Invert panel and place **18" legs** as shown.  
(Make sure legs are pushed all the way down).

### Step 2

Return bench to upright position.